



User Manual

LFP Battery

Pi LV1



Pytes Pi LV1 LFP Battery User Manual

Dear Customer,

Thank you for purchasing Pytes Pi LV1. Pi LV1 is developed and produced by Pytes to provide safe, reliable and high-performance energy storage solutions for residential, small commercial and industrial energy storage systems.

We strongly recommend that you carefully read this manual before install the Product and follow the instructions carefully during the whole installation process. This manual provides all the necessary information on installation, use of the Product. Please be advised that only qualified personnel (such as an electrician) should install and perform maintenance on the Product.

It is important to keep in mind the boundaries of use, as described in this manual. The Product is not intended for use in medical or aviation-related applications, and should only be used for its intended purpose as described in this manual. Improper use of the Product will void the warranty of the Product, and Pytes cannot be held responsibility for any damage caused by improper or incorrect use of the Product.

For your safety and the safety of others, please follow all user safety instructions during the use of the Product. This manual is intended for the installers and users of the Product.

Please keep this manual in a safe location, as it is the original manual. For the latest version of all manuals, please visit our website at <http://www.pytesgroup.com>.

Thank you again for choosing Pytes, and please do not hesitate to contact us if you have any questions or concerns about your Product.

Best regards,

Shanghai Pytes Energy CO., LTD.

Add: No.3492 Jinqian Road, Fengxian District, Shanghai, China

Website: <http://www.pytesgroup.com>

Email: ess_support@pytesgroup.com

Before Using

Read and understand the following instructions:

Warning

1. This equipment must be installed, operated and maintained by qualified personnel (electrician).
2. The local safety regulations and relevant operating procedures must be observed during the installation, operation and maintenance of the Product, otherwise the Product may get damaged. The safety precautions mentioned in the manual are only the supplement to local safety regulations.

Caution

1. Do not dispose of batteries in fire. The batteries may explode.
2. Do not open or mutilate batteries. Released electrolyte can prove harmful to the skin and eyes. It may be toxic.
3. A battery can present a risk of electric shock and burns by high short-circuit current.
4. A malfunctioned battery can reach temperatures that exceed the threshold of contact surface. The following precautions should be observed when working on batteries:

- a) Dis-connect the power and loads before connecting or disconnecting battery terminals;
- b) Do not wear any metal objects including watches and rings;
- c) Use tools with insulated handles;
- d) Do not lay tools or metal parts on top of batteries;
- e) Wear personal protective equipment.
- f) Make sure the battery is well grounded. Contact with any part of a poorly grounded or ungrounded battery can cause electric shock and burns by high short-circuit current. The risk of such hazards can be reduced if conductive surroundings are removed by a skilled and qualified personnel.

5. Before moving or reconnecting the running system, the power must be turned off and the system should be shut down, otherwise there will be a risk of electric shock.

6. Do not expose Li-ion battery to heat or fire. In case of fire, please use fire extinguisher.

7. Do not dismantle any part of the Product without contacting and permission from Pytes or Pytes authorized technical engineers. System failure caused by such action will not be covered by the warranty.

8. Before operating inverter, make sure that all batteries have been started up.

9. Battery needs to be re-charged within 12 hours after fully discharged.

10. Do not connect the Product with PV solar wiring directly.

11. The product should be installed in a restricted area without access to children and pet.









12. The battery should be charged within 12 hours when it's fully discharged or over-discharging protection mode is activated. Fail to follow this instruction will damage the battery and is not covered by warranty.

Danger

1. Keep the Li-ion battery away from water, dust and contamination, otherwise it may cause explosion or other harmful conditions that may even lead to personal injury.
2. Do not short-circuit the Li-ion battery.
3. Observe the positive (+) and negative (-) marks on the Li-ion battery and equipment and ensure correct use. Do not reverse connect the Li-ion batteries.

4. Do not dismantle, crush, puncture, open or shred the Li-ion battery.
5. Before removing or reconnecting with the running system, the power must be off and the system should be shut down, otherwise there will be a risk of electric shock.
6. Do not expose Li-ion battery to heat or fire. In case of fire, please use fire extinguisher.
7. Do not dismantle any part of the system without contacting PYTES or PYTES authorized technical engineers. System failure caused by such action will not be covered by the warranty.

Symbols

	Read the instruction manual before starting installation and operation.
	Caution, do not dispose of batteries in a fire, the battery may explode.
	Caution, a battery can present a risk of electric shock and burns by high short-circuit current. do not short-circuit the Li-ion battery.
	Caution, do not dispose the product with household wastes.
	Danger, keep the Li-ion battery away from water, dust and contamination, otherwise it may cause explosion or lead to personal injury.
	Danger, do not place near open flame or flammable materials.
	Danger, do not place at children or pet touchable area.
	Recyclable.

CONTENTS

1	Safety Precautions.....	7
1.1	Transportation	7
1.2	Storage	7
1.3	Emergency Situations	7
1.4	Disposal	8
2	Specifications.....	8
2.1	Parameters.....	8
2.2	Packing List	9
2.3	BMS function.....	10
3	Interface and protection functions.....	11
3.1	Interface Instructions.....	11
3.2	Components.....	13
4	Operating Environment	14
5	Installation and configuration.....	15
5.1	Installation preparation.....	15
5.2	Unpacking.....	16
5.3	Installation	16
6	Communication	21
6.1	RS232 port	22
6.2	RS485 port and CAN port	22
7	Troubleshooting	23
7.1	Unable to start	24
7.2	Unable to charge	24
7.3	Unable to discharge	25
7.4	Alarm Indicator Constantly on	25

1. Safety Precautions

1.1 Transportation

Pytes Pi LV1 original packaging complies with regulation of UN3480, Class 9, Packaging Group II. Always check all applicable local, national, and international regulations before transporting a LFP battery.

The battery must be transported in its original or equivalent package and in an upright position. Protect the battery from severe vibration, shock, squeeze, and exposure to rain and direct sunlight during transportation.

Use soft slings during loading and unloading process when battery is in its package to avoid damage. Do not lift the battery at the terminals or communication cable; only lift the battery at handles. Do not stand below a product when it's hoisted.

1.2 Storage

Follow the storage instructions in this manual to optimize the lifespan of the LFP battery during storage. If these instructions are not followed and the LFP battery has no energy remained when it is checked, consider it to be damaged. Do not attempt to recharge or use it. Replace it with a new LFP battery.

Disconnect the LFP battery from all loads, and the charging device if applicable.

Store the battery in a cool and dry place without direct sunlight.

Keep the battery away from corrosive substances, inflammable and explosive material as well as hazardous gases.

The Self-discharge of the LFP battery pack is 1-2% per month.

Charge the LFP battery to more than 90% of its rated capacity for long-term storage (>6months) every 6 months.

1.3 Emergency Situations

1) Leaking Batteries

If the battery pack leaks electrolyte, avoid contact with the leaking liquid or gas. If one is exposed to the leaked substance, immediately perform the actions described below.

Inhalation: Evacuate the contaminated area, and seek medical attention.

Contact with eyes: Rinse eyes with flowing water for 15 minutes, and seek medical attention.

Contact with skin: Wash the affected area thoroughly with soap and water, and seek attention.

Ingestion: Induce vomiting, and seek medical attention.

2) Fire

Only dry powder fire extinguisher can be used; if possible, move the battery pack to a safe area before it catches fire.

3) Wet Batteries

If the battery pack is wet or submerged in water, do not allow any person access, and then contact PYTES or an authorized dealer for technical support.

4) Damaged Batteries

Damaged batteries are dangerous and must be handled with extreme care. They are not suitable for use and may cause danger to persons or property. If the battery pack appears to be damaged, do not allow any person access, and then contact PYTES or an authorized dealer for support.

NOTE:

Damaged batteries may leak electrolyte or produce flammable gas.

In case a damaged battery needs recycling; it shall follow the local recycling regulation to process, and using the best available techniques to achieve a relevant recycling efficiency.

5) Short-Circuit

Only inspected and approved by qualified personnel (such as an electrician) when short-circuited, the system can be operated.

1.4 Disposal

Disposal of the batteries should be in accordance with local laws and regulations and should be carried out by an expert with specialized knowledge and experience in electrical and environmental safety, at designated waste disposal facilities using safe and appropriate method.

2. Specifications

2.1 Parameters

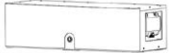



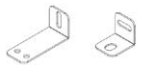



Table 1-1 Specifications







Item	Parameters					
System Model	Pi LV1					
Controller Model	Pi LV1 BCU					
Battery Model	Pi LV1 BMU					
Battery Model Chemistry	LFP					
Battery Model Quantity ^[1]	1	2	3	4	5	6
Nominal Voltage	51.2V					
Voltage Range	47.5V~56.8V					
Nominal Energy	5.12kWh	10.24kWh	15.36 kWh	20.48 kWh	25.6 kWh	30.72 kWh
Recommended Power	2.56kW	5.12kW	7.68KW	10.24KW	10.24KW	10.24KW
Dimensions (L*W*H) (mm/inch)	681*242*540 26.8*9.5*21.3	681*242*800 26.8*9.5*31.5	681*242*1060 26.8*9.5*41.7	681*242*1320 26.8*9.5*52.0	681*242*1580 26.8*9.5*62.2	681*242*1840 26.8*9.5*72.4
Weight(kg/lbs)	71.7/158.1	125/275.6	178.3/393.1	231.6/510.6	284.9/628.1	338.2/745.6
Efficiency	≥95%					
External Communication	CAN, RS485, WIFI, Dry Contact					
Internal Communication	RS232					
Cycle Life ^[2]	≥6000					
Calendar Life	≥10 Years					

Protection Level	IP55
Certificates	UN38.3, IEC62619, CE, UL1973, UL9540, UL9540A,
Operating Temperature	Charge: 0°C ~ 45°C / 32°F ~113°F Discharge: -10°C~50°C / 14°F~122°F
Storage Temperature	Within 1 month: -20°C~50°C / -4°F~122°F 1~3 months: -10°C~40°C /14°F~104°F 3~12 months: 0°C~30°C /32°F~86°F

[1]: 4 models parallel in Pi LV1 is Recommended.
[2]: @25°C, 0.5C Charging/Discharging, 90% DoD

2.2 Packing List

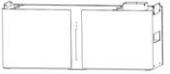
Package	Item	Qty	Specifications	Picture
BCU Package	Pi LV1 BCU	1		
	M5x10 Screws	8	Steel, Black zinc plating-Flat tail-Drop resistant-96H	
	M5x12 Bolts	6	GB 9074.13-1988-M5x12-Zinc plating Steel-NSS 72hrs	
	M5 Hexagon flange nuts	2	GB-T6177.1-M5-Zinc plating Steel-Drop resistant	
	M8x50 Expansion screws	2	GB-T22795(TGQ)-2008-M8X50-Zinc plating Steel-Silver	
	Wall Brackets	2	SGCC-60*25*26.5+30*25*26.5-Powder Coating-Black	
	Locking Pieces	2	SGCC-130*40*1.2-Powder Coatin-Black-RAL9005	
	M8x20 Screws	2	Outer hexagonal cross-GB-T9074.13-Flat Tail-Zinc Plating Steel-Silver	
	Waterproof EVA tape	4	70*40*2-HF-1-Black	

	Earthing Cable	1	UL1015-10AWG-1000mm-Yellow/Green-SC6-6*2	
	Spare RJ45 Connector	2		
	Pi LV1 Base1	1		
	User Manual	1		
BMU Package	Pi LV1 BMU	1	51.2V, 100Ah, LFP Battery Module	
	Locking Pieces	2	SGCC-130*40*1.2-Powder Coatin-Black-RAL9005	
	M5x10 Screws	8	Steel, Black zinc plating-Flat tail-Drop resistant-96H	

2.3 BMS function

Protection and Alarm	Management and Monitor
Charge/Discharge End Cut-off	Cells Balance
Charge over Voltage Protection	Intelligent Charge algorithm
Discharge under Voltage Protection	Charge/Discharge current Limit
Charge/Discharge Over Current Protection	Capacity Retention Calculation
High/Low Temperature Warning Over/Under Temperature Protection	Administrator Monitor
Short Circuit Protection	Log Record
Power Cable Reverse Protection	

3. Interface and protection functions

3.1 Interface Instructions

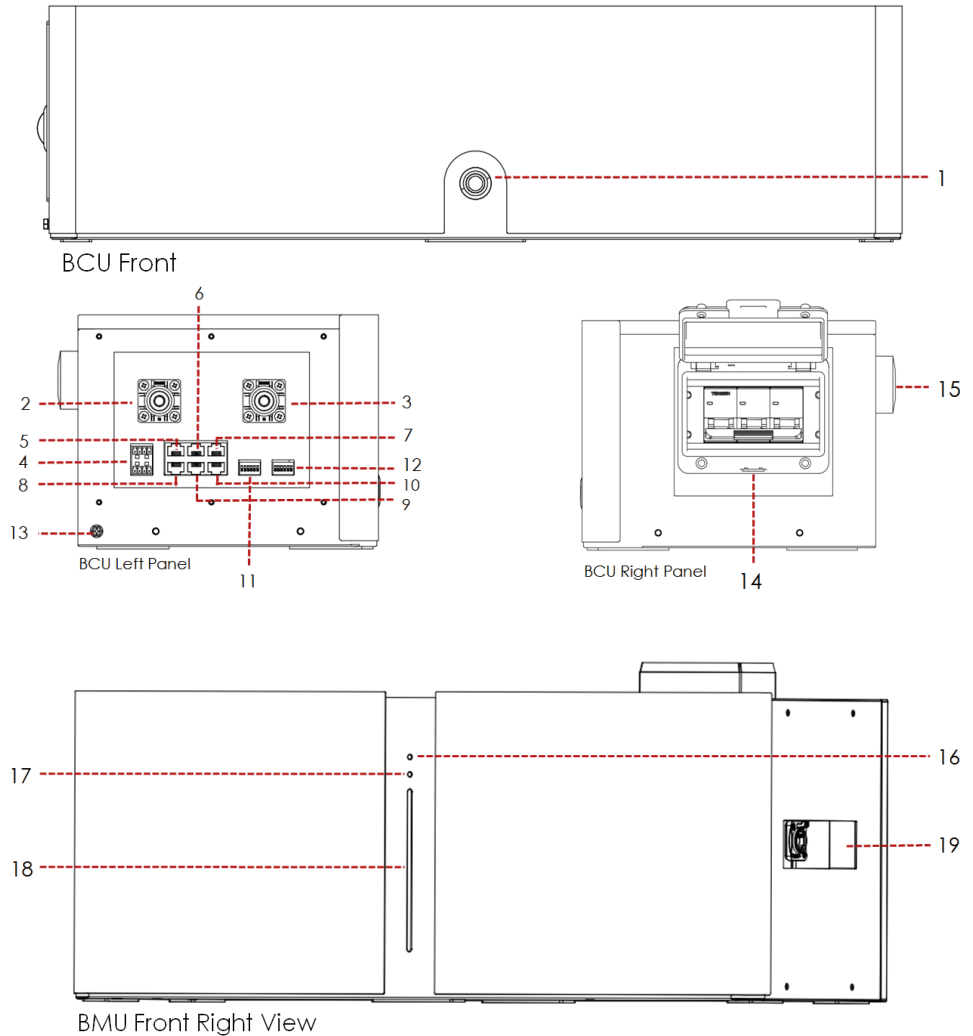

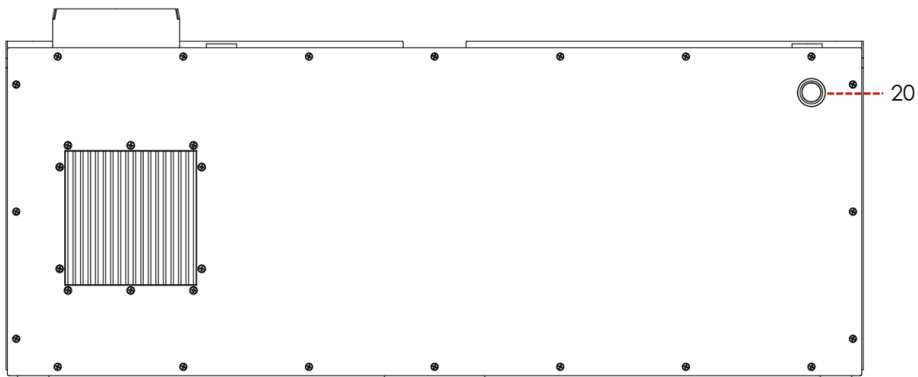

BMU Back

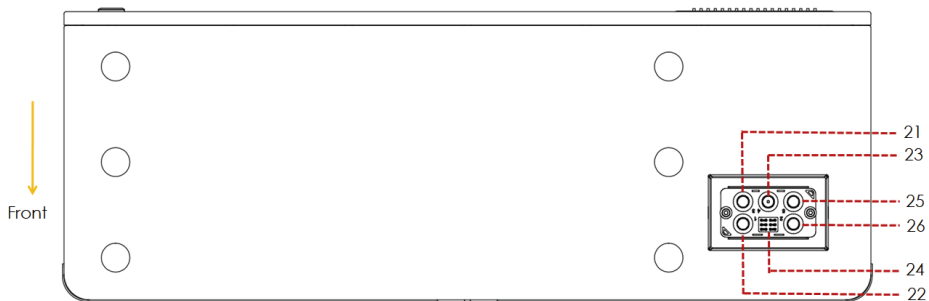

BMU Vertical View

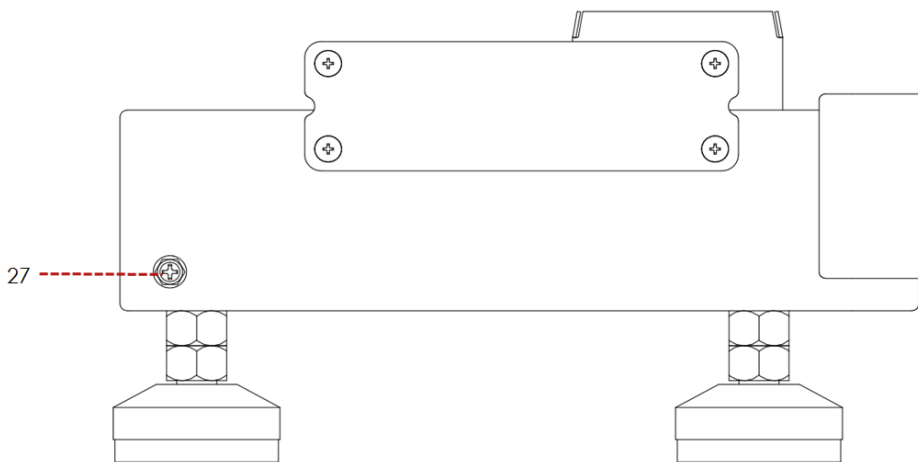

Base Side View

3.2 Components

No.	Unit	Name	Function description
1	Pi LV1 BCU	Soft power Button	Long Press for 0.5s to Power on/off Pi LV1.
2		Power terminal -	External power connector, negative, M8, to connect to PCS battery negative terminal.
3		Power terminal +	External power connector, positive, M8, to connect to PCS battery positive terminal.
4		Dry contact	Reserved.
5		Console	RJ45 port, follow RS232 protocol, to connect to PC for local system data monitoring and firmware upgrading.
6		CAN	RJ45 port, follow CAN protocol, to connect to PCS and output system information.
7		RS485	RJ45 port, follow RS485 protocol, to connect to PCS and output system information.
8		Link 1	Reserve.
9		Link 0	
10		Null	
11		DIP 1	Reserved
12		DIP 2	Protocol address to set for communicating with certain PCS.
13		Earthing Point 1	
14		DC Breaker	DC 125V, 375A.
15		IOT	WiFi Module for remote system data monitoring and firmware upgrading.
16		Running light	Green light. The light flashes when Standby. The light is constantly on when charging. The light flashes when discharging.
17		Alarm indicator	Red light. The light flashes when Alarming. The light is continuously on when protected.
18		Capacity indicator	Green lights show battery SOC. Each light represents 10% SOC.
19		RS232 port	RJ45 port, follow RS232 protocol, to connect to PC for local battery data monitoring and firmware upgrading.

20		Self-locking switch	Press to Power on/off individual BMU.
21		Internal power connector +	Positive power interface for parallel connection between BMUs, or the upper BMU to BCU.
22		Internal power connector +	Positive power interface for parallel connection between BMUs, or the upper BMU to BCU.
23		Internal earthing connector	Grounding point between BMUs or the upper BMU to BCU.
24		Cascade communication connector	for internal communication between BMUs or the upper BMU to BCU.
25		Internal power connector -	Negative power interface for parallel connection between BMUs, or the upper BMU to BCU.
26		Internal power connector -	Negative power interface for parallel connection between BMUs, or the upper BMU to BCU.
27	Pi LV1 Base	Earthing Point 2	

Warning: 6, 7 is DVC-A circuit, they shall not be connected to DVC-B/C circuit when installed, or hazard shock will occur.

4. Operating Environment

Battery Installation, operating, maintenance environment requirements:

- ◇ Operating Temperature: -10°C~50°C
- ◇ Relative Humidity: 20%-95%, no condensation
- ◇ Altitude: < 4000m
- ◇ Installation Location Conditions:
 - 1) no heat source, flammable or explosive materials.
 - 2) no direct sunlight.
 - 3) a restricted area that children or pet can't access.
 - 4) the floor to install the Product is flat and level.
 - 5) no puddle water.
 - 6) minimal dust and dirt.
 - 7) minimum 0.5meters away from PCS.
 - 8) no cover or wrap to the Product.

5. Installation and configuration

5.1 Installation preparation

5.1.1 Safety Requirements

Only those who have been trained in the power system and have a good knowledge of the power system are allowed to install the Product. Always observe local safety regulations and the safety requirements listed below during the installation process.

Before installing or removing the battery, make sure that the system is disconnected from any power source and that the battery is off state. Distribution cabling needs to be handled carefully with protective measures.

5.1.2 Checking the operating environment

The operating environment should meet the requirements described in Chapter 4, “Operating Environment”.

5.1.3 Tools and Safety Gears

The tools that may be used are shown in Table 5-1.

Table 5-1 Tools

Tools		
Screwdriver	Electric Drill	Pencil
Cable Clamp	Wire Cutter	Ruler

Use properly insulated tools to prevent accidental electric shock or short circuits. If insulated tools are not available, cover the entire exposed metal surfaces of the available tools, except their tips, with electrical tape.

Safety Gear		
Insulated Gloves	Safety Goggles	Safety shoes

It is recommended to wear safety gears when dealing with the Product.

5.1.4 Technical preparation

Electrical interface settings:

If the battery is connected to the user device directly, please check:

- ◇ Whether the DC charging interface of the energy storage inverter meets charging voltage and current requirements in Table 1-1 Specifications.
- ◇ Whether the power of the electrical equipment matches the parameters listed in “Table 1-1 Specifications”.

Security check:

Fire-fighting equipment such as portable fire extinguishers should be available near the Product. Follow the instructions in Chapter 4 for environment requirements.

5.2 Unpacking

- ◇ When the battery arrives at the installation site, it must be unloaded and stored properly and prevented from the direct sunshine and rain. Before installation, check if there is any component missing according to 2.2 Packing List and check whether the box appearance is intact;
- ◇ Carefully handling the unpacking to preserve the insulation coating on the casing's surface;
- ◇ Please contact PYTES if there is any damage or missing of products and / or components.

5.3 Installation

Note

All installation and operation must comply with local electrical standards.

5.3.1 Single Stack Parallel Installation

5.3.1.1 Place Pi LV1 Base to Determine Specific Installation Location

- 1) Place the Pi LV1 along the wall. Leave 30mm~35mm/1.18~1.38inch between back of Pi LV1 base and wall.

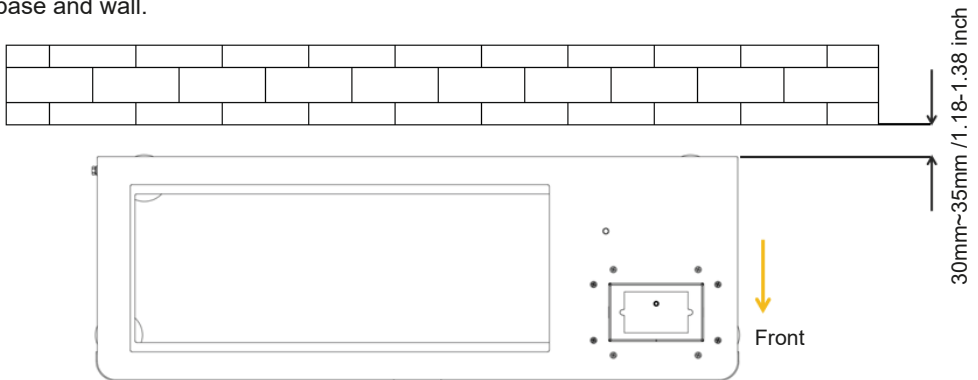

5.3.1.2 Team Lift to Stack up Pi LV1

- 2) Place the Pi LV1 BMU onto base. Pay attention to BMU direction so that the connectors of base and BMU are at the same side. Fix the BMU to base with Locking Pieces*2 and M5x10*8 Screws.

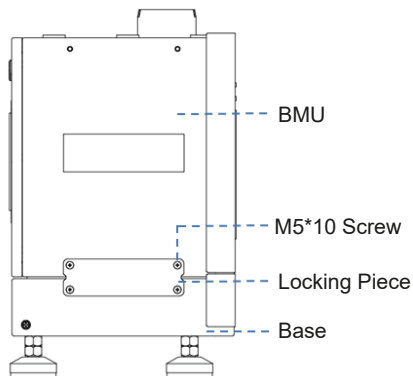

3) Repeat the operations. The corresponding interface terminals being stacked up one by one to connect Pi LV1 BMUs (team lift). Fix neighbouring modules to each other with Locking Pieces and M5x10 Screws.

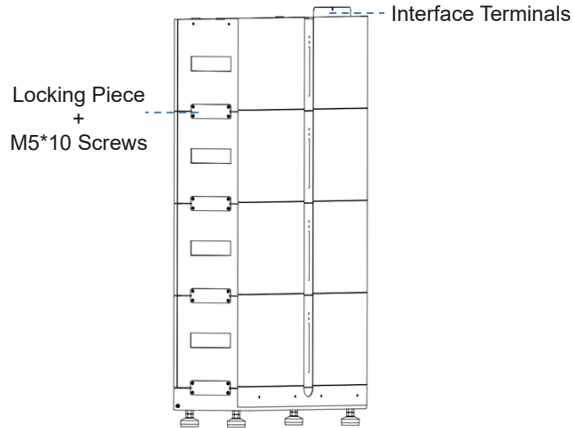

4) Install BCU part of wall bracket*2 to back of Pi LV1 BCU with M5*12 Bolts*6.

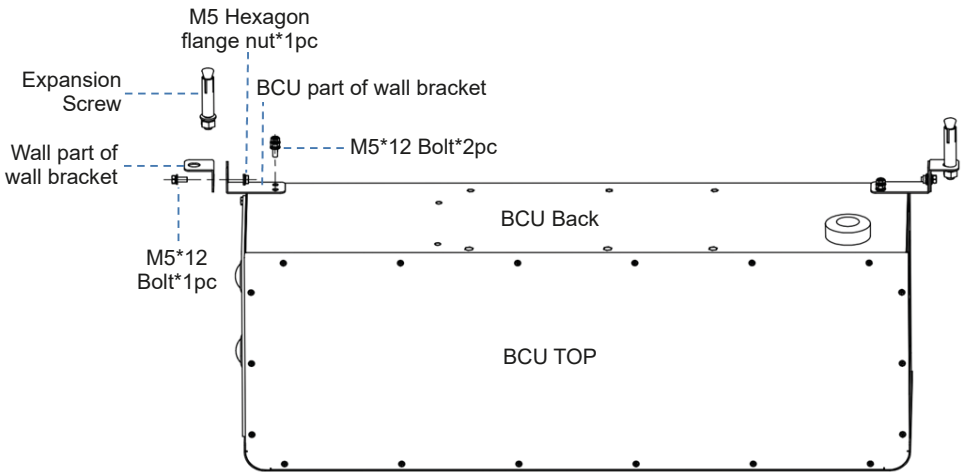

5) Placing Pi LV1 BCU on top of the system and hold the wall part of wall bracket. Use pencil to mark expansion screw position on wall for electricity drill work. Ensure there's no cables laid in the wall to avoid damage to the cables when drilling.

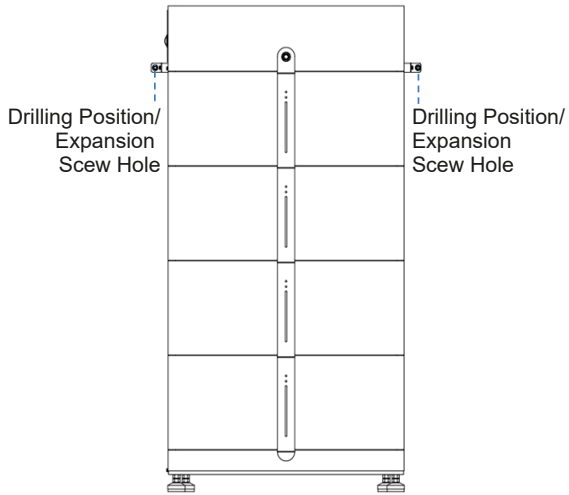

6) Set the Pi LV1 aside and drill the holes, then insert the expansion screws into the holes. Fix the wall part of wall Bracket to Wall with M5*12 Bolts*2.

Place Pi LV1 BCU to top and fix the two parts of wall brackets (wall part and BCU part) together with M5 Hexagon flange nuts*2

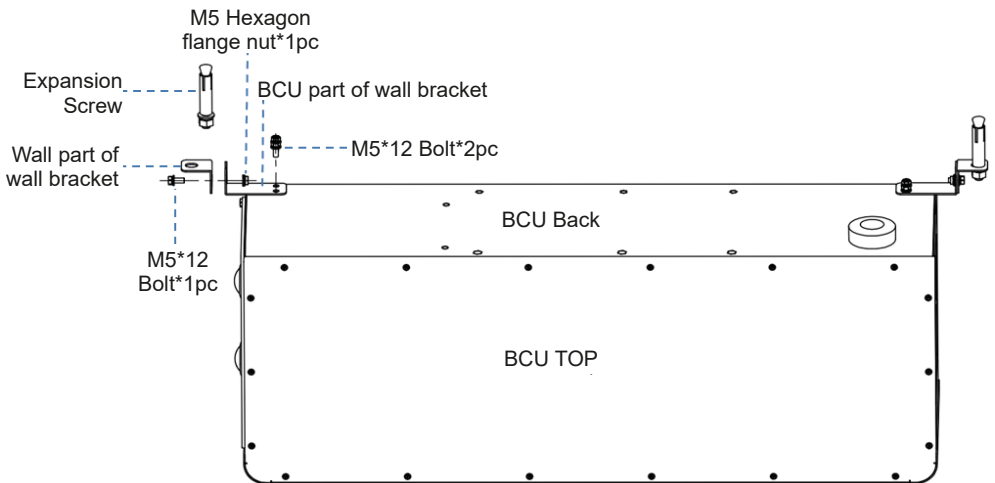

Warning: To avoid risk of collapse, Pi LV1 modules must be firmly locked to each other and BCU must be firmly installed to wall with the locking pieces and wall brackets provided in the Product package.

5.3.1.3 Cabling

7) Loosening 6 screws from left side panel.

Align the T90 lug end of the external power cables to power terminals on Pi LV1 BCU, positive to positive and negative to negative, fix the lug to terminal with M8*20 screws.

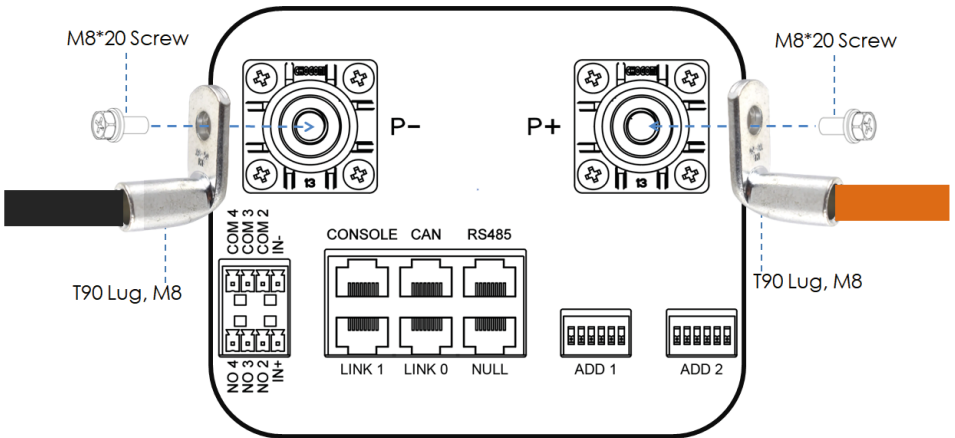

Note:

Before connecting the power cable, connect and disconnect the cable to identify the positive and negative terminal, then make a mark respectively. After the cable is connected, measure whether there is short-circuit or reverse connection.

8) Stick the EVA tape to external communication cable, 135mm/5.3" away from RJ45 connector end. Then to connect it to CAN/RS485 port.

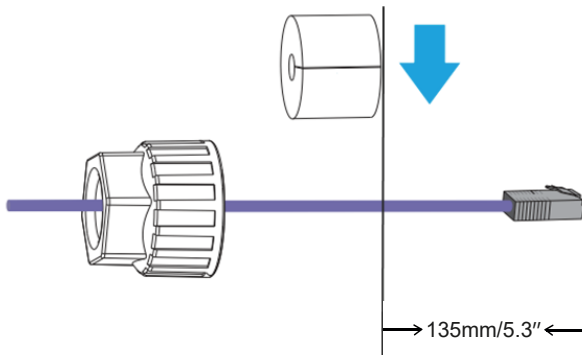

Please refer to Chapter 6.2 for information of communication ports.







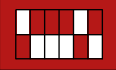
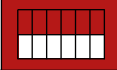
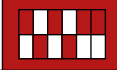
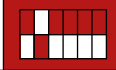
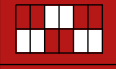
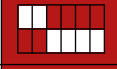
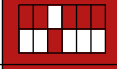
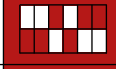

9) There are two grounding points on Pi LV1. Please refer to 3.1 & 3.2.

Connect one end of earthing cable to either grounding points and the other end of the earthing cable to a reliable ground point.

External Bi-polar over current protection devices and Bi-polar external isolator shall be equipped. The minimum diameter of earthing cable must be $\geq 6\text{mm}^2$.

Note: The grounding resistance should be less than 0.1Ω .

10) Set PCS communication address on DIP 2.

DIP on 1uHub - PCS Communication Protocol Address							
Solark		Victron		Solis		Deye	
Luxpower		Goodwe		Growatt		SMA	
Megarevo		Afore		Phocos		Voltronic	
SRNE		MUST		Studer		Hoymiles APsystem	

* White column indicates the DIP bar.

Pytes may update DIP address setting from time to time due to new PCS integration without further notice.

Please contact us for latest version.

11) Loosen the gland on side panel and thread the cables through gland holes of side panel. Install the side panel back to Pi LV1 BCU, together to tighten the glands.

12) WiFi Setting

Pi LV1 is integrated with WIFI for remote viewing battery data and firmware upgrading. Please read our user manual of the WIFI dongle for setting details.

5.3.2 Procedure of starting/Shut down the whole system

Start Procedure

Note: Before starting the system, strictly check the connection terminals to ensure that the terminal is firmly connected. Make sure Pi LV1 is powered on prior to turn on the inverter. This is to avoid battery shock by the in-rush current of the large capacitors of the inverter.

Step 1. Press self-locking switch on back of each BMU to turn on the BMUs.

Step 2. Turn on breaker on right side panel of BCU.

Step 3. Long Press soft power button on front of BCU for 0.5s to power on Pi LV1.

Step 4. Turn on the external breaker between Pi LV1 and PCS if applicable.

*Make sure that all batteries have been powered on, then to turn on the inverter. This is to avoid battery shock by the in-rush current of the large capacitors of the inverter.

Shut down Procedure

Step 1. Switch off the PCS.

Step 2. Long press soft power button on front of BCU for 0.5s, then to press the self-locking switch of first BMU next to BCU to turn off the system.

Step 3. Wait for the indicator light to go off.

Step 4. Turn off breaker on right side panel of BCU to power off Pi LV1.

5.3.3 Multi Stacks Connection

Pi LV1 supports up to 3 stacks parallel connected.

A 1uHub should be introduced in system to manage multi stack communication.

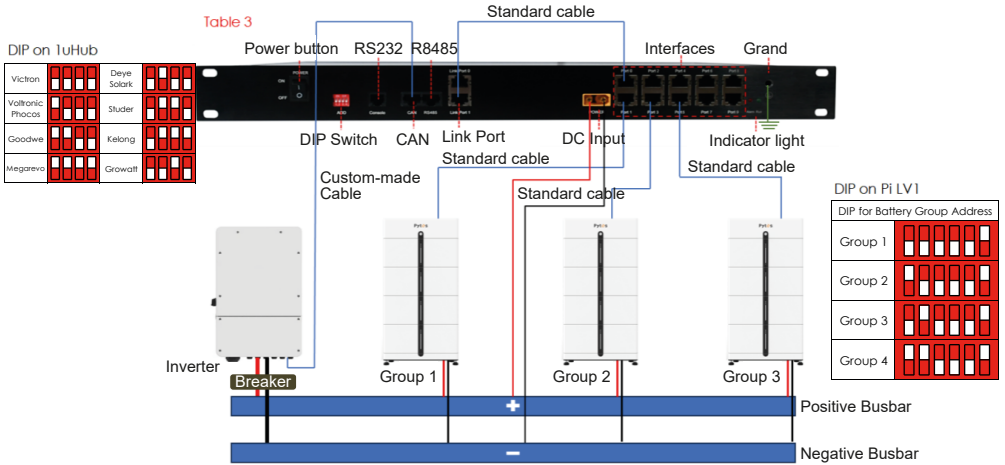

Note:

DIP on 1uHub is protocol address to communicate with PCS.

DIP on each Pi LV1 BCU is CAN communication address.

---End of installation---

6 Communication

There are RS-232C, RS485 and CAN communication ports on the Product. The battery status can be obtained and the battery internal parameters can be modified via Pytes monitoring software.

CAN

CAN communication Terminal (RJ45 port) follow CAN protocol, to output batteries information.

RS485

RS485 Communication Terminal: (RJ45 port) follow RS485 protocol, to output batteries information.

RS232

RS232 Communication Terminal: (RJ45 port) follow RS232 protocol, to upgrade the software and communicate with your PC.

6.1 RS232 port

Default baud rate of RS-232C ports: 115200bps.

Table 6-1 RS232 Connector Pin Assignments

Pin number	RS-232C port
1	
2	
3	RXD
4	GND
5	
6	TXD
7	
8	

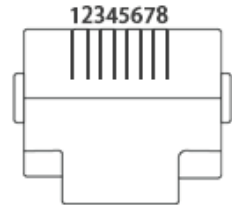

6.2 RS485 port and CAN port

Default baud rate of RS-485 port: 9600bps

Default baud rate of CAN port: 500K

Table 6-2 RS485 and CAN Connector Pin Assignments

Pin number	Serial	CAN
1	RS485B	
2	RS485A	
3	GND	
4		CANH
5		CANL
6	GND	
7	RS485A	
8	RS485B	

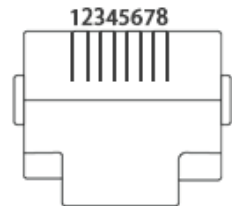

7 Troubleshooting

Table 7-1 Pi LV1 BCU

Pi LV1 System Status	Normal/Alarm/Protection	ALM	RUN	Description
		●	○	
Shutdown	/	off	off	All off
Standby	Normal	off	Blink 1	Standby
	Alarm	Blink 3	off	Low Voltage
Charge	Normal	off	on	Upper Capacity LED Blink 2, Lower Capacity LED on
	Alarm	Blink 3	off	
	Protection	on	off	Protection triggered, charging stops
Discharge	Normal	off	Blink 3	
	Alarm	Blink 3	off	
	Protection	on	off	Protection triggered, discharging stops
Failure	Failure	on	off	Detected failure on Relay/Current

Notes: Blink descriptions: Blink 1*0.5s on/1.5s off"; Blink 2 *0.5s on/0.5s off"; Blink 3*1s on/1s off";

Table 7-2 Pi LV1 BMU

Pi LV1 BMU Status	Normal/Alarm/Protection	ALM	RUN	Capacity LED 10 Lights	Descriptions
		●	●	●	
Shut down	/	OFF	OFF	All off	All off
Standby	Normal	OFF	Blink 1	All off	Standby
	Alarm	Blink 3	OFF	All off	Low Voltage
Charging	Normal	OFF	ON	Based on Capacity	Upper Capacity LED Blink 2, Lower Capacity LED on
	Alarm	Blink 3	ON		
	Protection	ON	OFF	All off	Protection triggered, charging stops
Discharge	Normal	OFF	Blink 3	Based on Capacity	Protection triggered, discharging stops
	Alarm	Blink 3	Blink 3		

	Protection	ON	OFF	All off	
Failure	Failure	ON	OFF	All off	Detected failure on cell or temperature sensor or voltage, MOS etc

Notes: Blink descriptions: Blink 1*0.25s on/3.75s off; Blink 2*0.5s on/0.5s off; Blink 3*0.5s on/1.5s off;

Please refer to the troubleshooting methods mentioned below. Please read Table 7-1 and Table 7-2 of this manual before troubleshooting to prevent false operations. For example, it doesn't indicate the battery is faulty if the ALM alarm red light is blinking or constantly on. When there is an "alarm" indication, it usually works well and needs no troubleshooting. When there is "protection" indication, the battery will work normally automatically after "protection" status is released.

7.1 Unable to start

Problem	Troubleshooting Steps	Solution
Press the POWER button to the "ON" state but the LED indicator doesn't respond or all the LEDs are off after 1second.	<ol style="list-style-type: none"> 1. Confirm that the DC Breaker on BCU is in the "ON" state and all the POWER buttons on BMUs remain in the "ON" state; 2. Charge the battery correctly and observe if the battery can be charged properly. 	<ol style="list-style-type: none"> 1. If the battery enters charging mode, the battery can return to normal after charging. 2. If not, please contact the local reseller or Pytes.

7.2 Unable to charge

Problem	Troubleshooting Steps	Solution
The battery can't be charged properly while it's not fully charged.	<ol style="list-style-type: none"> 1. Confirm that the battery is turned on; 2. Check the power cable. Confirm that the power cables are correctly connected and the charging circuit is correct; 3. Check the BCU indicator LED to see if the system is under "Protection" state. If so, find the cause of the protection, and fix the problem, then restart the battery; 4. Check if the charging voltage meets the battery charging requirements. If not, adjust the power supply voltage to the proper range. 	If the battery still does not charge properly after following the steps, please contact the local reseller or Pytes.

7.3 Unable to discharge

Problem	Troubleshooting Steps	Solution
<p>The battery can't be discharged properly.</p>	<ol style="list-style-type: none"> 1. Confirm that the battery is turned on; 2. Check the power cables to ensure that they are properly connected. 3. Unplug the battery power cable and measure the battery power output voltage. If the battery voltage is below 47.5V, charge it immediately. 4. Check the BCU indicator LED to see if the battery is under "Protection" state. If so, find the cause of the protection, and fix the problem, then restart the battery; 	<p>If the battery still does not discharge properly after following the above steps, please contact the local reseller or Pytes.</p>

7.4 Alarm Indicator Constantly on

When the ALM indicator is constantly red and the other indicators are off, the battery is in the "Protection" state. When the condition triggered protection is released, the battery will automatically return to normal operation. There are a few issues requiring immediate measures.

Problem	Troubleshooting Steps	Solution
<p>The ALM indicator is constantly red and all other indicators are off.</p>	<ol style="list-style-type: none"> 1. Check the power cables to ensure that they are properly connected. 2. Check whether the charging voltage, charging/discharging current, battery/cell voltage and temperature meet the relevant protection conditions, and release the "protection" state to ensure that the voltage, current and temperature are within the normal working range. find the cause of the protection, and fix the problem, then restart the battery; 	<p>If the battery protection state can't be released, or the ALM indicator is constantly on when the battery is properly charged after it is restarted, please contact your local reseller or Pytes.</p>

Warning: Do not repair the battery without authorization from Pytes!

Warranty Card

Customer Information			
Contact Name			
Phone Number		Email	
Address			
Product Information			
Battery Model		Inverter Brand/Model	
Battery Quantity		Inverter Quantity	
Purchase Date		Inverter Using Time	
Serial Number		on/off Grid	
Installer Information			
Installer Name		Installation Date	
Problem Description			
Photos of Battery Wiring			
Photos of Inverter Wiring and Panels			



Shanghai PYTES Energy Co., LTD

Add: No.3492 Jinqian Road, Fengxian District, Shanghai, China

Tel: +86 21 57475852

Email: ess_support@pytesgroup.com