

# **SMA Sunny Island with PYTES Battery Installation & Configuration Manual**

---

## Contents

SMA Sunny Island with PYTES Battery Installation & Configuration Manual.....	1
<b>1.BOM List</b> .....	3
<b>2.System Overview</b> .....	4
<b>3. Electrical and communication connections</b> .....	4
3.1 Power Cable Connection .....	4
3.2 Communication Cable Connection .....	5
3.3 Dip Switch .....	6
<b>4. Operation &amp; Monitoring</b> .....	6
4.1 Commissioning the Inverter.....	6
4.2 Log in.....	8

## 1.BOM List

Item	Remarks	Quantity
<b>Power Cable (DC)</b>	<input type="checkbox"/> Conductor cross-section: 50 mm <sup>2</sup> to 95 mm <sup>2</sup> <input type="checkbox"/> Cable diameters: 14 mm to 25 mm <input type="checkbox"/> Only copper cables may be used. <input type="checkbox"/> The DC cables must be sized for the maximum battery voltage and the maximum battery current (see battery manufacturer documentation).	Depends on the number of batteries and the connection method
<b>CAN Cable</b>	CAN communication Terminal (RJ45 port) follow CAN protocol, to output batteries information	1
<b>Twist Pair Cable</b>	For Ethernet Connection between PC and Inverter	1
<b>PC (Personal Computer)</b>	Provide for oneself	1
<b>Battery</b>	48100R / 48100C / 4850	Depends on the number of batteries and the connection method
<b>Inverter</b>	SMA SUNNY ISLAND	1

## 2. System Overview

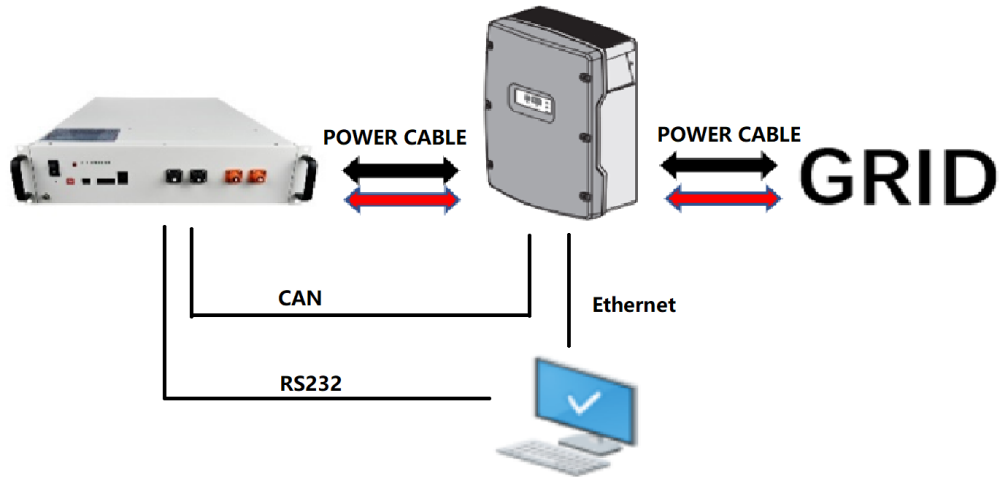

## 3. Electrical and communication connections

### 3.1 Power Cable Connection

Open the front housing of the SMA sunny island and connect the red and black cables to the inverter DC connector as shown in Figure 3.1.

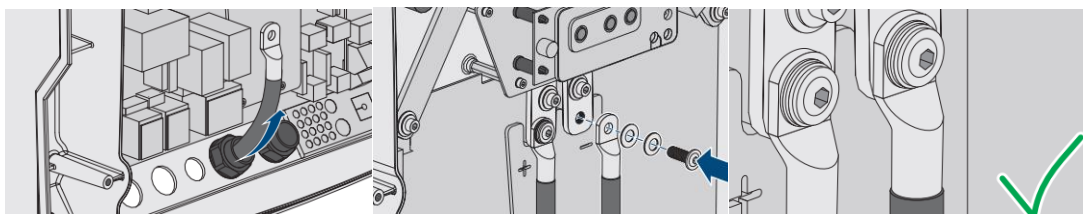

Figure 3.1

At the other end of the cable, connect to the positive and negative battery connectors, as shown figure 3.2. (Ensure that the battery power switch is off)

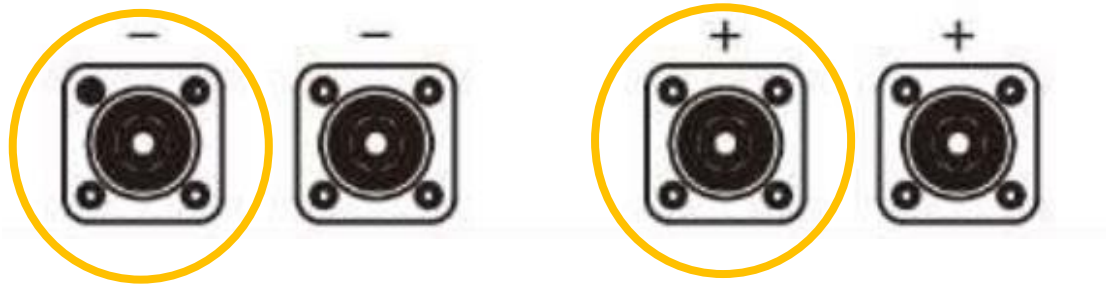
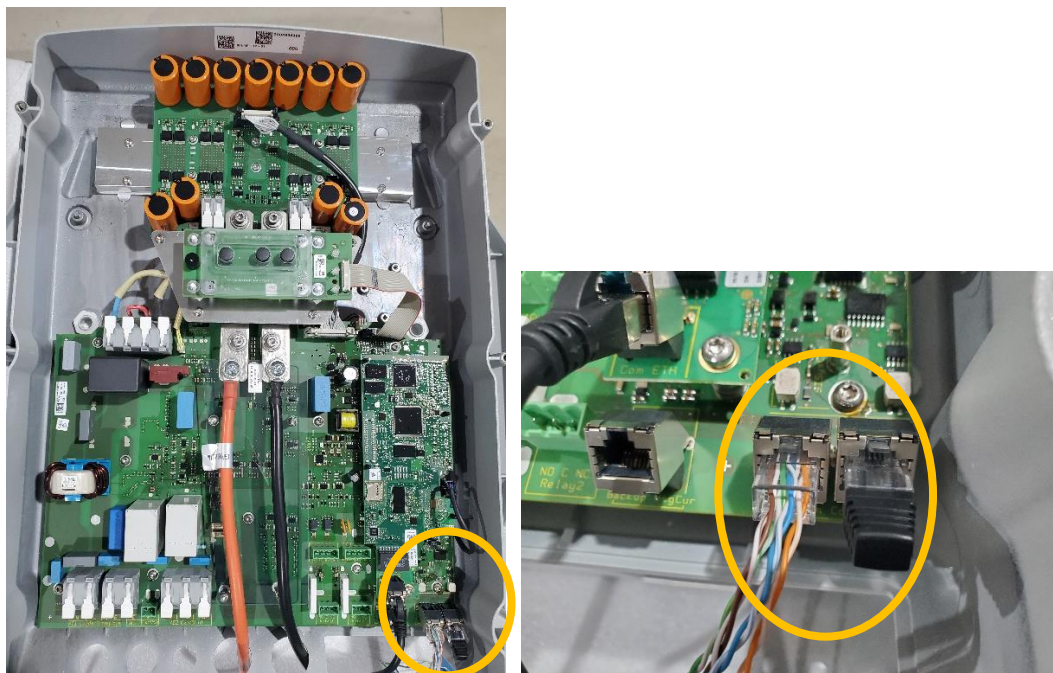

Figure 3.2

### 3.2 Communication Cable Connection



This cable is used for communicating with the battery.

Connect the other end of the cable to the battery communication port as shown in Figure 3.3. (Make sure the correct sequence of wires inside the communication cable as below)

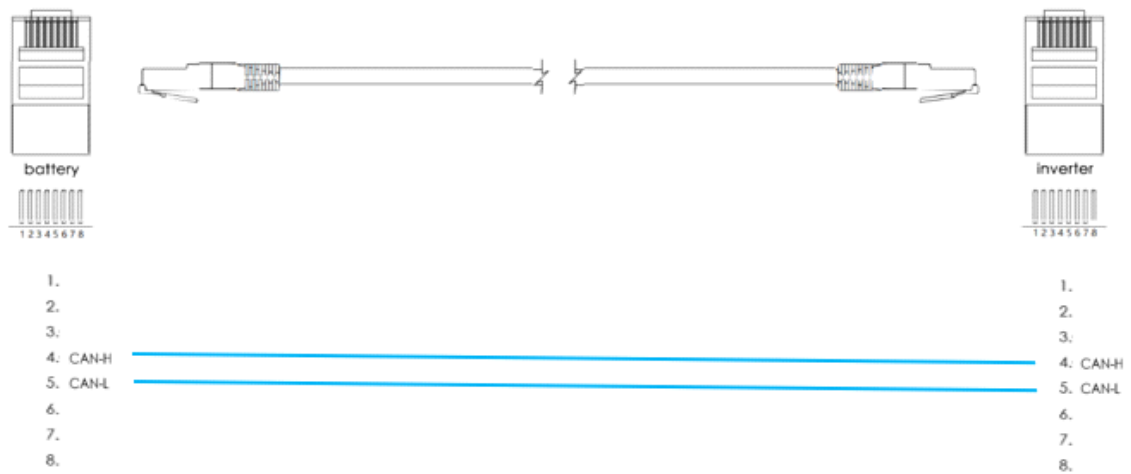

Figure 3.3

### 3.3 Dip Switch

Set the ADD switch as shown in Figure 3.4



Figure 3.4

## 4. Operation & Monitoring

### 4.1 Commissioning the Inverter

Connect the Ethernet cable as shown in Figure 4.1, Connect the other end of the cable to your laptop or PC.



Figure 4.1

Turn on the battery power switch, Press and hold the SW switch until the RUN indicator on the battery lights up.



Turn on the DC switch of the inverter and the light turns green as shown in Figure 4.2

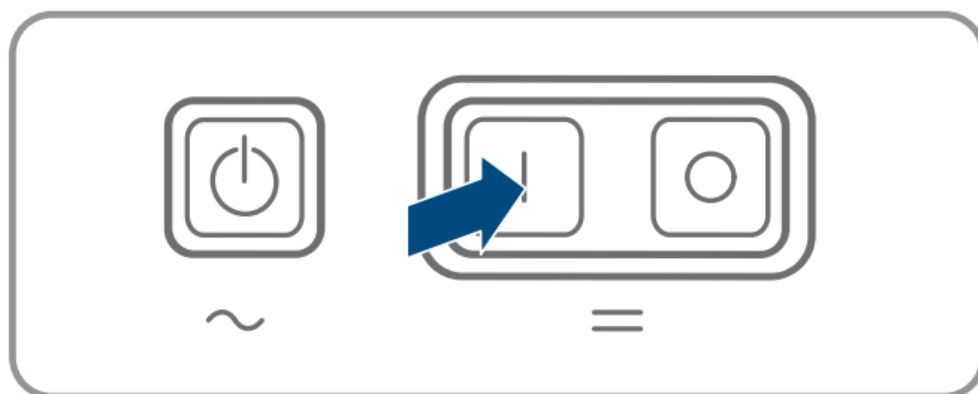
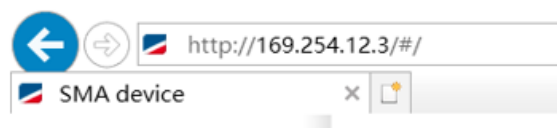



Figure 4.2

## 4.2 Log in

Turn on your computer and Open your browser , type in the web bar the URL: **169.254.12.3**



The following web page will appear:

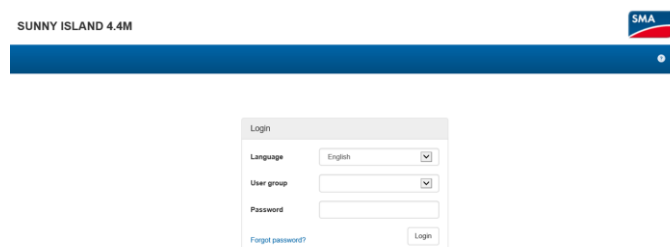

### Log in as Installer or User for the First Time

1. In the drop-down list Language, select the desired language.
2. In the Password field, enter a password for the User user group.
3. In the Repeat password field, enter the password again.
4. Click on Save.
5. In the New password field, enter a password for the Installer user group. Assign a uniform password to all SMA devices to be registered in a system. The installer password is also the system password.
6. In the Repeat password field, enter the password again.
7. Click on Save and log in.

The installation assistant or the home page of the user interface opens.



## Log in as the User or Installer

1. In the drop-down list Language, select the desired language.
2. In the User group drop-down list, select the entry Installer or User.
3. Enter the password in the field Password.
4. Select Login.

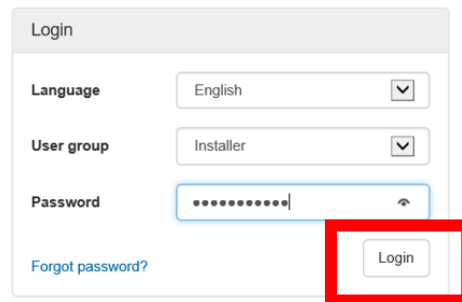

Login

Language English

User group Installer

Password .....

Forgot password?

Login

The start page of the user interface opens.

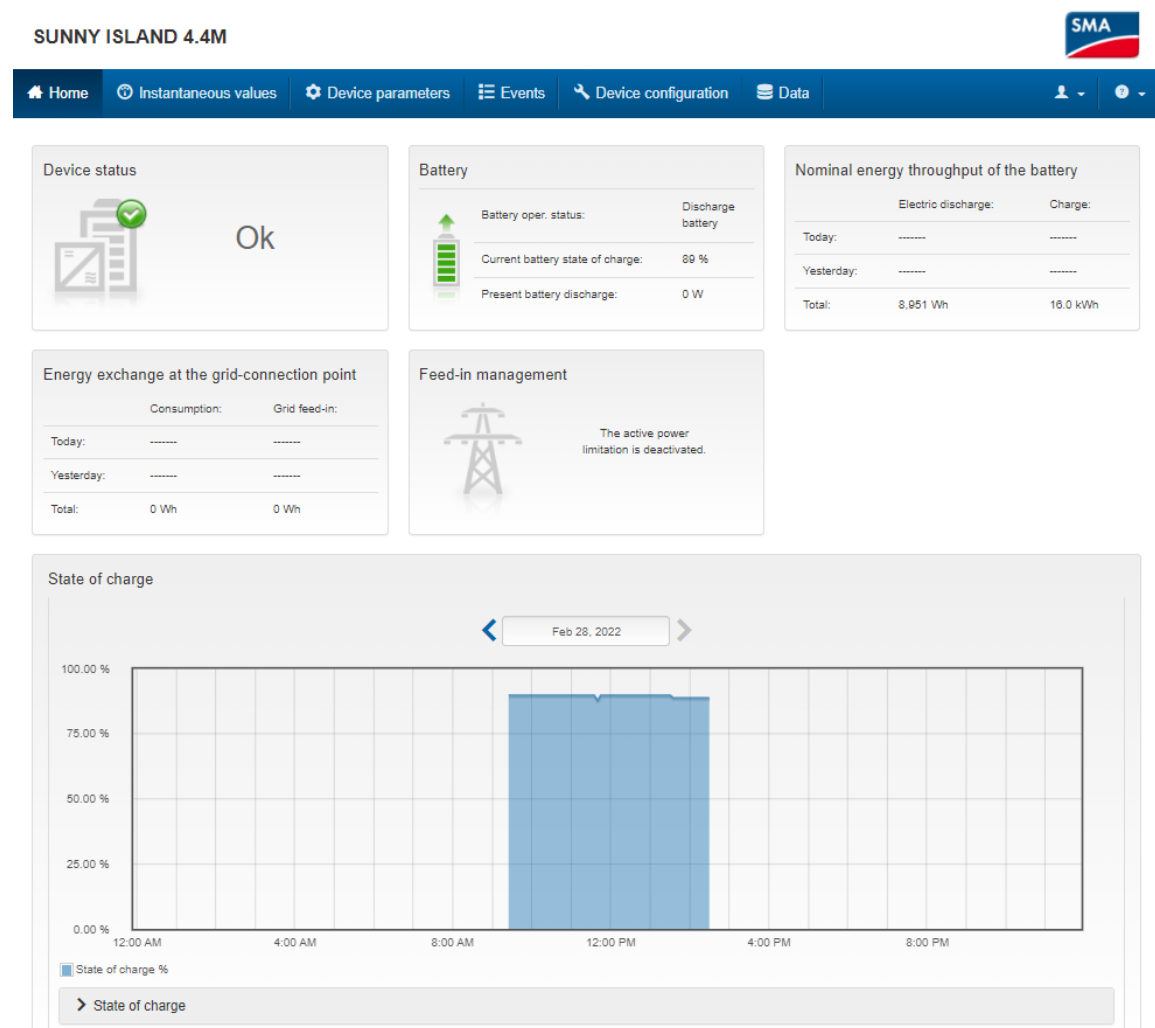

If the communication between the battery and the inverter is successful, the main page displays OK.

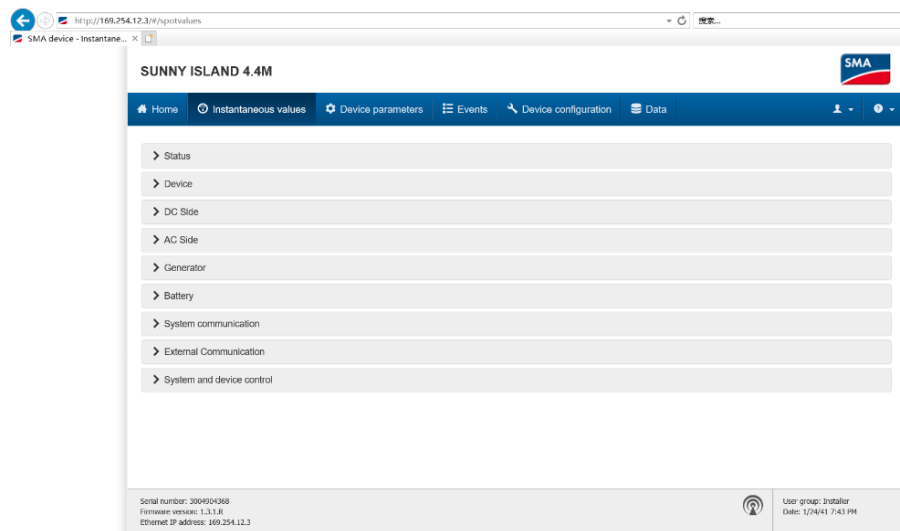

Real-time status of inverter and battery and grid can be viewed in page “instantaneous values”.

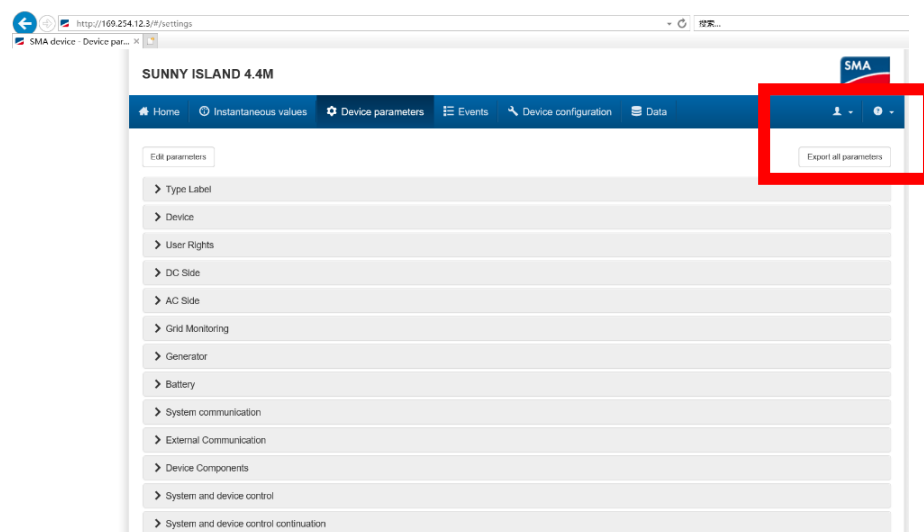

Export all parameters

The parameters of the inverter can be modified in page “Device parameters”, “Export all parameters” can generate a data table in html format for all the current parameters

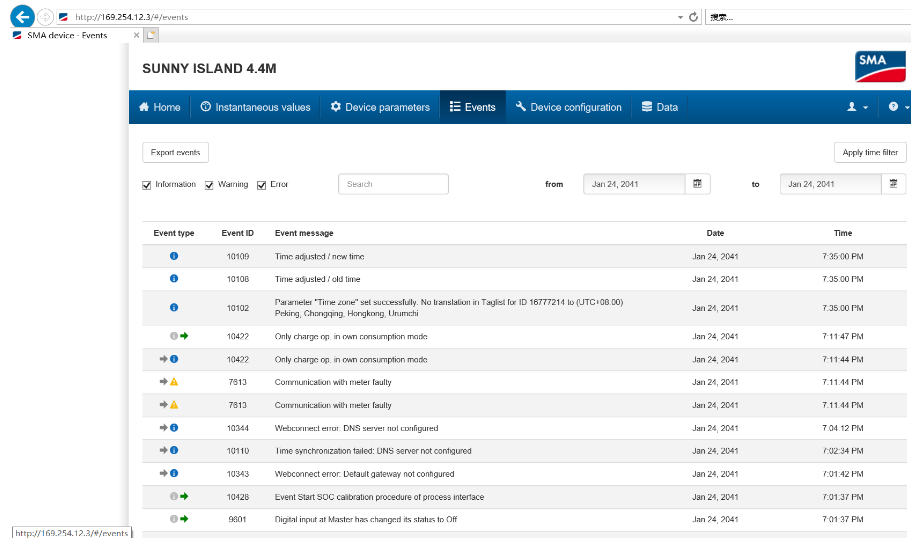

Event type	Event ID	Event message	Date	Time
Information	10109	Time adjusted / new time	Jan 24, 2041	7:35:00 PM
Information	10106	Time adjusted / old time	Jan 24, 2041	7:35:00 PM
Information	10102	Parameter "Time zone" set successfully. No translation in Taglist for ID 16777214 to (UTC+08:00) Peking, Chongqing, Hongkong, Urumchi	Jan 24, 2041	7:35:00 PM
Information	10422	Only charge op. in own consumption mode	Jan 24, 2041	7:11:47 PM
Information	10422	Only charge op. in own consumption mode	Jan 24, 2041	7:11:44 PM
Warning	7513	Communication with meter faulty	Jan 24, 2041	7:11:44 PM
Warning	7513	Communication with meter faulty	Jan 24, 2041	7:11:44 PM
Warning	10344	Webconnect error: DNS server not configured	Jan 24, 2041	7:04:12 PM
Warning	10110	Time synchronization failed: NTP server not configured	Jan 24, 2041	7:02:34 PM
Warning	10343	Webconnect error: Default gateway not configured	Jan 24, 2041	7:01:42 PM
Information	10426	Event Start SOC calibration procedure of process interface	Jan 24, 2041	7:01:37 PM
Information	9501	Digital input at Master has changed its status to Off	Jan 24, 2041	7:01:37 PM

Each operation record and alarm will appear in the "Events" interface.

**Note: If you want to get more inverter-related settings, please refer to the inverter user manual**

**- END -**